

# LED PANEL

Product&amp;Family Code: 056 005 0009

**SLIM/ Sq-9**

WHITE

## Technical Drawing

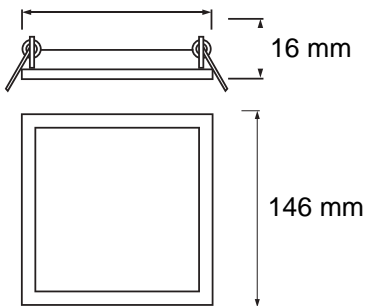
 135x135

## Photometric Diagram

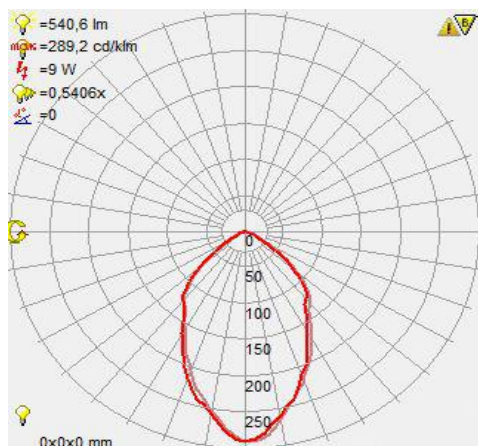

## Technical Data

Voltage (V)	100-265V
Product Wattage (W)	9
Equivalence with incandescent lamp(W)	72
Colour Render Index (Ra)	>Ra70
Colour Temperature (K)	2700K / 4200K / 6400K
Materials	Aluminium
Protection Class	II
Dimmable	No
EEI	A to A++
Warm-up time up to 60 %of the full light output	Instant Full Light
Luminous Flux (lm)	540
Luminous Efficacy (lm/W)	60
Rated Life (hrs) ⌚	50.000
IP Rating	20
Power Factor	>0.5
Beam Angle	120°
Starting Time	<0.2s
Number of ON-OFF cycling	x25.000

## Applications

- Office Lighting, Meeting Rooms, Restaurants, Hospitals, all indoor applications.



## Features

- High Lumen and CRI, Good quality & Constant Current driver.
- High heat dissipation, low carbon and environmental protection.
- SMD LED Lamp Base.
- Very low energy consumption.

